

elite

range of products

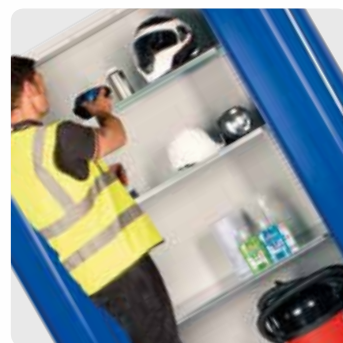

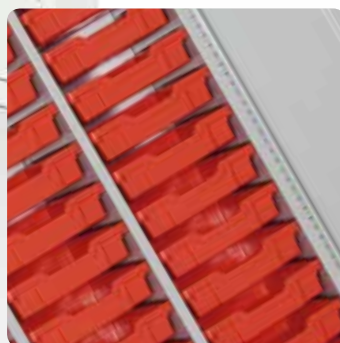
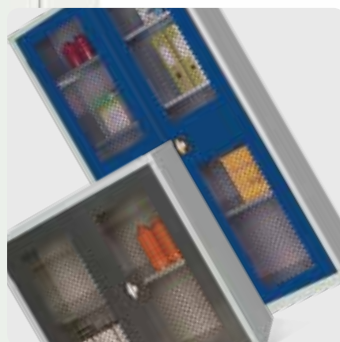
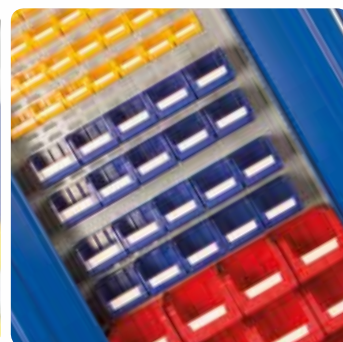
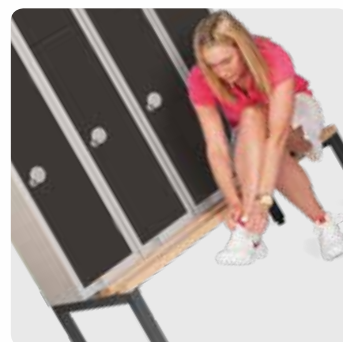
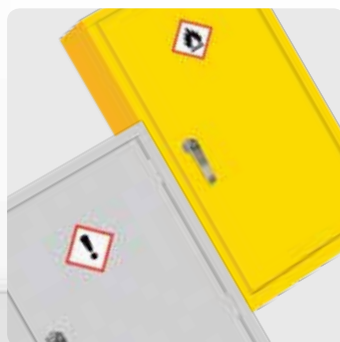

storage lockers

Compartment Lockers	3 - 5
PPE Lockers	6
All White Lockers	7
Workwear Lockers	8
Space Saving Lockers	9
Garment Handling Lockers	10
Extra Capacity Lockers	11
Personal Effects Lockers	12 - 13
In-Charge Lockers	14
Laminate Door Lockers	15
Perforated and Wire Mesh Lockers	16
Vision Panel Lockers	17
Cloakroom Lockers and Stainless Steel Lockers	18
Plastic Lockers	19
Locker Accessories	20 - 21

educational

School Cloakroom	22 - 23
Low Height Lockers	24
Modular Storage Lockers	25

cloakroom

Cloakroom Equipment	26 - 27
Bench Seating	27

hazardous

Dangerous Substance Safety Cabinets	28 - 29
Hazardous Substance Coshh Cabinets	30 - 31
Dangerous Substance Floor Chests	32
Galvanised Bin Units	33
Hazardous Substance Stainless Steel Cabinets	33

cupboards

Cupboards	34
Louvered Panel & Mesh Fronted Cupboards	35
Extra Wide Cupboards	36
Slim Cupboards	37
First Aid Cabinets	38
PPE Cabinets	39
High Capacity Storage Cupboards	40
Tray Storage & Teachers Cupboards	41

info

Bespoke Manufacture	42 - 44
Locker Room Design	45
Locker Opening Dimensions	46
Seats & Stands	47
Stands	47



These steel coloured lockers are manufactured to the highest specification.

Lockers are welded and riveted in construction. Semi concealed hinges are welded to the door and riveted to the frame, allowing easy replacement of doors. Doors are fixed within a rebated frame to enhance compartment security. Selected doors are reinforced with profiled steel sections. Top and bottom plinths are vented to create an airflow to assist with air changes.

The carcass incorporates nesting holes on all sides and a return flange at the base for extra strength and to reduce floor damage. Lockers are manufactured using CR4 and bright galvanised steel components. Material thickness specification 0.9mm doors and frame, 0.7mm carcass and shelves. Painted components are epoxy polyester powder coated prior to assembly to ensure all surfaces are protected. Nested lockers are manufactured with common sides. The materials used classifies this locker as a fire retardant product meeting the BS Class '0' rating.



Available colour options on selected products. Components are pre-treated with an iron-phosphate chemical process prior to a satin gloss epoxy polyester powder coating paint finish. Bespoke colour options available on application.

- Anti-bacterial powder coating - elite **GUARD**
- Robust steel construction, 0.7 - 0.9mm steel thickness
- Welded frame design
- Comprehensive locker accessories
- 4000 differ series key cam lock for added security
- Cloakroom equipment available
- Keyless locking options available



Direct deliveries to the end user or traders business address included in the rrp pricing. Deliveries to commercial premises only, does not include deliveries to private addresses. Deliveries to kerbside only, nearest point of entry to the premises. Any delivery restrictions, e.g. size of vehicle, height and weight should be noted at time of order, extra charges will be incurred if a smaller/non-standard sized vehicle is necessary to complete the delivery. Redelivery charges will apply for a failed delivery. Specific day deliveries can be arranged for full vehicle loads only, extra charges may apply.



Components of products that feature an epoxy powder coated paint finish will incorporate an anti-bacterial additive which is 99.9% effective against E.coli, MRSA and moulds for the life of the product. These products are ideally suited for use in the healthcare, food, pharmaceutical industries and in areas where hygiene is important.



Various products contain a mix of steel finishes and component thicknesses, the icon indicates the range of steel thicknesses used in the product.



Cloakroom island seating is supplied flat packed and will require assembly on site. Freestanding benches supplied assembled. Cloakroom lockers require assembly.



Tray storage cupboards will require the trays and runners to be loaded into the cupboard. Instruction guide will be included within the product packaging. The trays and runners are delivered separately from the cupboard.



100% manufactured in the UK. Steel sourced from UK steel stockholders. Locker components e.g. locks sourced outside of the UK.



Locker/Cupboard test sample components complied with the requirements for BS 'Class 0' surface, as defined in paragraph A13 (b) of approved document B, 'Fire Safety', to the building regulations 2000. The result of the tests to BS 476: Part 6:1989+A1: 2009 and BS 476: part 7: 1997, demonstrate that the products, as tested, complies with the requirements for 'Class 0'.



Lockers manufactured with an air-flow venting system incorporated in the top and bottom locker plinth.

- Anti-bacterial powder coating, satin gloss finish
- Robust steel construction with rebated doors and welded frame
- Lockers complemented with sloping tops, stands and combined seat & stand options
- Keyless locking options available



Standard door colour options



All lockers supplied with mid grey carcass

Security Features

4000 differ series lock
 semi concealed door hinges
 steel profiled door stiffeners*
 welded locker frame
 mastered cam lock series

*One, two, three, four and five door lockers





one door locker

PRODUCT CODE	SIZE	CLEAR ENTRY	SINGLE	NEST OF 2	NEST OF 3
	H x W x D mm	H x W x D mm			
1830301	1800 x 300 x 300	1410 x 235 x 275	✓	✓	✓
1830451	1800 x 300 x 450	1410 x 235 x 425	✓	✓	✓
1845451	1800 x 450 x 450	1410 x 385 x 425	✓		

Supplied with a top shelf and double coat hook

two door locker

PRODUCT CODE	SIZE	CLEAR ENTRY	SINGLE	NEST OF 2	NEST OF 3
	H x W x D mm	H x W x D mm			
1830302	1800 x 300 x 300	835 x 235 x 275	✓	✓	✓
1830452	1800 x 300 x 450	835 x 235 x 425	✓	✓	✓
1845452	1800 x 450 x 450	835 x 385 x 425	✓		

Supplied with a double coat hook in each compartment

three door locker

PRODUCT CODE	SIZE	CLEAR ENTRY	SINGLE	NEST OF 2	NEST OF 3
	H x W x D mm	H x W x D mm			
1830303	1800 x 300 x 300	540 x 235 x 275	✓	✓	✓
1830453	1800 x 300 x 450	540 x 235 x 425	✓	✓	✓

Supplied with no internal fittings

four door locker

PRODUCT CODE	SIZE	CLEAR ENTRY	SINGLE	NEST OF 2	NEST OF 3
	H x W x D mm	H x W x D mm			
1830304	1800 x 300 x 300	400 x 235 x 275	✓	✓	
1830454	1800 x 300 x 450	400 x 235 x 425	✓	✓	
1845454	1800 x 450 x 450	400 x 385 x 425	✓		

Supplied with no internal fittings

five door locker

PRODUCT CODE	SIZE	CLEAR ENTRY	SINGLE	NEST OF 2	NEST OF 3
	H x W x D mm	H x W x D mm			
1830305	1800 x 300 x 300	310 x 235 x 275	✓	✓	
1830455	1800 x 300 x 450	310 x 235 x 425	✓	✓	

Supplied with no internal fittings

six door locker

PRODUCT CODE	SIZE	CLEAR ENTRY	SINGLE	NEST OF 2	NEST OF 3
	H x W x D mm	H x W x D mm			
1830306	1800 x 300 x 300	260 x 235 x 275	✓	✓	
1830456	1800 x 300 x 450	260 x 235 x 425	✓	✓	

Supplied with no internal fittings

eight door locker

PRODUCT CODE	SIZE	CLEAR ENTRY	SINGLE	NEST OF 2	NEST OF 3
	H x W x D mm	H x W x D mm			
1830308	1800 x 300 x 300	185 x 235 x 275	✓		
1830458	1800 x 300 x 450	185 x 235 x 425	✓		

Supplied with no internal fittings

550mm deep lockers available - ask for details.

Bespoke lockers e.g. extra shelves non-standard sizes - ask for details

nested lockers...

Cost savings...
manufactured
with common
sides, cannot
be separated.



Only single and nest of 2 lockers can be supplied with sloping tops.



- Galvanised internal shelves
- Welded frame design
- Locker accessories, pages 20-21
- Doors individually labelled 'Personal Protective Equipment'



Robust Industrial Strength

Locker compartment doors are individually labelled with 'Personal Protective Equipment' mandatory label and incorporates an escutcheon plate to apply vinyl numbering for compartment identification. Product codes prefixed PPE will be supplied with a mid grey carcass and blue doors.

Single door unit supplied with a top shelf and double coat hook. Two door unit supplied with double coat hook to each compartment.

Four and six door units have no internal fittings.

Standard door colour option



All lockers supplied with mid grey carcass

ppe lockers 300mm deep

PRODUCT CODE	SIZE H x W x D mm	DESCRIPTION
PPE1830301	1800 x 300 x 300	one door
PPE1830302	1800 x 300 x 300	two door
PPE1830304	1800 x 300 x 300	four door
PPE1830306	1800 x 300 x 300	six door

ppe lockers 450mm deep

PRODUCT CODE	SIZE H x W x D mm	DESCRIPTION
PPE1830451	1800 x 300 x 450	one door
PPE1830452	1800 x 300 x 450	two door
PPE1830454	1800 x 300 x 450	four door
PPE1830456	1800 x 300 x 450	six door



- Anti-bacterial powder coating RAL 9010
- Robust steel construction
- All components powder coated

elite

all white lockers



all white lockers 300mm deep

PRODUCT CODE	SIZE H x W x D mm	DESCRIPTION
1830301W	1800 x 300 x 300	one door
1830302W	1800 x 300 x 300	two door
1830303W	1800 x 300 x 300	three door
1830304W	1800 x 300 x 300	four door
1830305W	1800 x 300 x 300	five door
1830306W	1800 x 300 x 300	six door
1830308W	1800 x 300 x 300	eight door

all white lockers 450mm deep

PRODUCT CODE	SIZE H x W x D mm	DESCRIPTION
1830451W	1800 x 300 x 450	one door
1830452W	1800 x 300 x 450	two door
1830453W	1800 x 300 x 450	three door
1830454W	1800 x 300 x 450	four door
1830455W	1800 x 300 x 450	five door
1830456W	1800 x 300 x 450	six door
1830458W	1800 x 300 x 450	eight door

Popular locker accessories...



Seat & Stand

See page 20



Sloping Top
Factory Fitted

See page 20



Stand

See page 21

Locker accessories supplied in RAL 9010.





combi locker

- Ideal for hanging workwear clothing and equipment storage
- Vertical hanging compartment with hanging rail plus smaller storage compartments
- Galvanised internal components
- Sloping top option

PRODUCT CODE	SIZE H x W x D mm
1845N	1800 x 450 x 450

See page

21

Stands help maintain a clean hygienic environment



clean & dirty locker

- Two vertical hanging compartments to separate workwear and daywear
- Seat and stands available
- Lock options available

PRODUCT CODE	SIZE H x W x D mm
1845CD	1800 x 450 x 450

See page

20

Sloping tops prevent the build up of debris. Factory fitted



Standard door colour options



All lockers supplied with mid grey carcass

elite

space saving lockers



two person locker

- Space saving unit for 2 users
- Each user having a vertical hanging and a smaller personal possession compartment
- Sloping top option
- Lock options available

PRODUCT CODE SIZE H x W x D mm
1845TP 1800 x 450 x 450

See page

20



Seat & Stand
Ideal when users are changing clothing & footwear

twin locker

- Space saving unit
- Accommodates two users each having a slim vertical storage compartment with shelf and double coat hook
- Sloping top option

PRODUCT CODE SIZE H x W x D mm
1845TW 1800 x 450 x 450

See page

20-21



Lock options,
single or multiple user applications

garment collector

PRODUCT CODE	SIZE H x W x D mm
721518GC	1830 x 381 x 457

- Sloping top option

garment dispenser

PRODUCT CODE	SIZE H x W x D mm	DESCRIPTION
721518GD5	1830 x 381 x 457	five door
721518GD10	1830 x 381 x 457	ten door
721518GD15	1830 x 381 x 457	fifteen door

- Lock options available
- Optional stands available
- Sloping top option



Standard door colour option

All lockers supplied with mid grey carcass



garment service locker

- Combines a personal storage locker with a single garment dispenser compartment
- Space saving unit
- Top compartments accessed by a keyed alike key, allows for a laundry service No access to personal compartments
- Lower user compartments suitable for clothing, footwear and small item storage
- Sloping top option

PRODUCT CODE	SIZE - H x W x D
183845GS	1800 x 380 x 450

Standard door colour options



All lockers supplied with mid grey carcass





elite

extra capacity lockers

- Ideal for those users requiring additional hanging and storage space
- Extra security with 3 point locking
- Welded frame construction
- Reinforced door
- Galvanised internal components

Standard door colour options



All lockers supplied with mid grey carcass

◀ clothing locker

PRODUCT CODE

SIZE H x W x D mm

722418CD

1830 x 610 x 457

Clothing cupboard with a central divider and hanging rails plus hooks

▼ equipment locker

PRODUCT CODE

SIZE H x W x D mm

722418N

1830 x 610 x 457

Hanging compartment with rail plus hooks.
Additional storage compartments to maximise space.

▼ wardrobe locker

PRODUCT CODE

SIZE H x W x D mm

722418W

1830 x 610 x 457

Adjustable shelf fitted with a hanging rail.



elite

personal effects lockers

wall mountable



Standard door colour options



All lockers supplied with mid grey carcass

Ideal for the storage of watches, jewellery, wallets, purses and mobile phones.

Designed for use off the floor, positioned on a suitable load bearing plinth.

- Four and eight door available
- Key cam lock supplied with 2 keys
- Available with USB charging ports
- Stackable with nesting holes to form banks
- Keyless lock options available



PRODUCT CODE	SIZE H x W x D mm	OPENING SIZE H x W x D mm	DESCRIPTION
PEL4FT	920 x 250 x 160	180 x 165 x 135	four door
PEL8FT	920 x 250 x 160	75 x 165 x 135	eight door
PEL4ST	920/990 x 250 x 160	180 x 165 x 135	four door with sloping top
PEL8ST	920/990 x 250 x 160	75 x 165 x 135	eight door with sloping top



- High density storage
- 1800mm or 940mm high
- Robust steel construction
- Rebated door for extra security
- Lock options available
- Available with vinyl numbering
- Sloping top option



PRODUCT CODE	SIZE H x W x D mm	DESCRIPTION
PEL20	1800 x 450 x 380	twenty door
PEL10	940 x 450 x 380	ten door

Standard door colour options



All lockers supplied with mid grey carcass

Cost effective high density storage solution for mobile phones and small personal items. Available in a choice of two heights..... 1800mm high twenty compartment unit plus a 940mm high ten compartment unit. Available with a 4000 differ series cam lock, supplied with two keys. Can also be supplied with a keyless locking solution with the use of a padlock fitting or combination locks.

The clear entry opening is 150h x 165w x 360d mm. Designed to be floor standing and can easily be nested or anchored to a wall for increased stability and security using the available nesting holes on the back and sides of each unit. Sloping top and stands available.



Vinyl numbering option



elite

in-charge lockers



The charger keeps pace with rapidly changing USB charging technology by providing both Type A and the latest Type C USB ports, the latter providing up to 3A at 5vDC, with class leading efficiency.

four door wall mounted locker with sloping top

PRODUCT CODE	SIZE H x W x D mm	OPENING DIMENSIONS H x W x D mm
STARTER		
ICPEL4ST	990 x 250 x 190	180 x 165 x 135
ADD-ON		
ICPEL4STAD	990 x 250 x 190	180 x 165 x 135

Maximum 24 USB charging sockets per starter lead. Power can be taken from a standard 240V socket supply.

eight door wall mounted locker with sloping top

PRODUCT CODE	SIZE H x W x D mm	OPENING DIMENSIONS H x W x D mm
STARTER		
ICPEL8ST	990 x 250 x 190	75 x 165 x 135
ADD-ON		
ICPEL8STAD	990 x 250 x 190	75 x 165 x 135

Maximum 24 USB charging sockets per starter lead. Power can be taken from a standard 240V socket supply.

Standard door colour options



All lockers supplied with mid grey carcass

four door floor standing locker

PRODUCT CODE	SIZE H x W x D mm	OPENING DIMENSIONS H x W x D mm
STARTER		
IC1830304	1800 x 300 x 330	400 x 235 x 275
IC1830454	1800 x 300 x 480	400 x 235 x 425
ADD-ON		
IC1830304AD	1800 x 300 x 330	400 x 235 x 275
IC1830454AD	1800 x 300 x 480	400 x 235 x 425

Maximum 24 USB charging sockets per starter lead. Power can be taken from a standard 240V socket supply.

six door floor standing locker

PRODUCT CODE	SIZE H x W x D mm	OPENING DIMENSIONS H x W x D mm
STARTER		
IC1830306	1800 x 300 x 330	260 x 235 x 275
IC1830456	1800 x 300 x 480	260 x 235 x 425
ADD-ON		
IC1830306AD	1800 x 300 x 330	260 x 235 x 275
IC1830456AD	1800 x 300 x 480	260 x 235 x 425

Maximum 24 USB charging sockets per starter lead. Power can be taken from a standard 240V socket supply.

eight door floor standing locker

PRODUCT CODE	SIZE H x W x D mm	OPENING DIMENSIONS H x W x D mm
STARTER		
IC1830308	1800 x 300 x 330	185 x 235 x 275
IC1830458	1800 x 300 x 480	185 x 235 x 425
ADD-ON		
IC1830308AD	1800 x 300 x 330	185 x 235 x 275
IC1830458AD	1800 x 300 x 480	185 x 235 x 425

Maximum 24 USB charging sockets per starter lead. Power can be taken from a standard 240V socket supply.



USB sockets prevent the use of non-certified/aftermarket plug-in chargers



- Impact resistance doors material thickness 12mm
- Rebated door for extra durability and aesthetics
- Security divider between compartments
- All internal components are a hardwearing galvanised finished
- Semi concealed hinges, no unsightly hinge plate cover
- Steel carcass with an anti-bacterial finish
- Suitable for dry room environments only
- Standard locker accessories available

laminite sgl door locker / heavy duty locker

PRODUCT CODE	SIZE H x W x D mm	DESCRIPTION
TL1830301	1800 x 300 x 300	one door
TL1830451	1800 x 300 x 450	one door
TL1845451	1800 x 450 x 450	one door
TL1830302	1800 x 300 x 300	two door
TL1830452	1800 x 300 x 450	two door
TL1845452	1800 x 450 x 450	two door
TL1830303	1800 x 300 x 300	three door
TL1830453	1800 x 300 x 450	three door
TL1830304	1800 x 300 x 300	four door
TL1830454	1800 x 300 x 450	four door



These heavy duty lockers are manufactured using 12mm solid grade laminate material for the doors and are attached to a steel carcass incorporating a welded frame and are an ideal choice for those environments where lockers are prone to misuse and vandalism.

Available with a wide variety of lock options suitable for single and public user modes. Unique semi concealed 5 knuckle hinges are strong and robust and uniquely designed to eliminate the need for unsightly hinge plate covers on the face of the laminate door. Top and bottom plinth vented to help increase air movement.

Locker door configurations include 1, 2, 3 & 4 door. Standard locker accessories available include laminate end panels, sloping tops and stands. This locker is only suitable for use in dry environments. Minimum order quantity applies to this product.

Standard door colour options



All lockers supplied with mid grey carcass



Extra strong semi concealed 5 knuckle hinge without unsightly hinge plate covers



Security between compartments improved with a specially designed compartment separator



Internal locker components benefit from a hardwearing galvanised finish



Doors manufactured using 12mm thickness solid grade laminate material in a variety of colours and wood effect options

elite

perforated lockers

- Increases compartment ventilation
- Reinforced doors
- Available on the complete range of lockers. Ask for details

Standard door colour options



All lockers supplied with mid grey carcass



elite

wire mesh lockers

- Offers high visual security
- Ideal for airing damp clothes
- Suitable for drying rooms
- 3 point locking, single and two door only
- Bright zinc & powder coated finish available
- Multi compartment mesh units 12, 16 and 20 compartments available. Ask for details



PRODUCT CODE	SIZE	DESCRIPTION	SINGLE	NEST OF 2	NEST OF 3
	H x W x D mm				
781212M1	1980 x 305 x 305	one door	✓	✓	✓
781218M1	1980 x 305 x 457	one door	✓	✓	✓
781212M2	1980 x 305 x 305	two door	✓	✓	✓
781218M2	1980 x 305 x 457	two door	✓	✓	✓
781212M4	1980 x 305 x 305	four door	✓	✓	✓
781218M4	1980 x 305 x 457	four door	✓	✓	✓
781212M6	1980 x 305 x 305	six door	✓	✓	✓
781218M6	1980 x 305 x 457	six door	✓	✓	✓



- Allows compartment inspection from outside the door
- Deters concealment within locker
- Engineered Plastic (PET) clear vision panel
- Steel framed rebated door for extra strength and rigidity

- Available on 2, 4, 6 and 8 door lockers
- Sloping top option
- £1 coin/token lock available
- Key cam lock, padlock fitting or combination lock options available

Standard door colour options



All lockers supplied with mid grey carcass



PRODUCT CODE	SIZE H x W x D mm	DESCRIPTION	SINGLE	NEST OF 2	NEST OF 3
1830302VP	1800 x 300 x 300	two door	✓	✓	✓
1830452VP	1800 x 300 x 450	two door	✓	✓	✓
1830304VP	1800 x 300 x 300	four door	✓	✓	
1830454VP	1800 x 300 x 450	four door	✓	✓	
1830306VP	1800 x 300 x 300	six door	✓		
1830456VP	1800 x 300 x 450	six door	✓		
1830308VP	1800 x 300 x 300	eight door	✓		
1830458VP	1800 x 300 x 450	eight door	✓		

elite

cloakroom lockers

- Maximises available space with multiple storage compartments plus garment hanging feature
- Lock options available



cloakroom lockers

PRODUCT CODE	SIZE H x W x D mm	NUMBER OF COMPARTMENTS
11ARCH	1800 x 1500 x 450	11
19ARCH	1800 x 2100 x 450	19



elite

stainless steel lockers

Specifically designed for use in environments that demand high levels of hygiene. Constructed from 1.2mm 304 grade stainless steel components that are welded and riveted together that offers a durable product.

- Practical hygienic storage solution
- Products are able to withstand hosing down or use of a pressure washer
- Lock options
- Sloping tops and stands available

stainless steel lockers

PRODUCT CODE	SIZE H x W x D mm	DESCRIPTION
CCK30301	1800 x 300 x 300	one door locker
CCK30451	1800 x 300 x 450	one door locker
CCK45451	1800 x 450 x 450	one door locker
CCK30302	1800 x 300 x 300	two door locker
CCK30452	1800 x 300 x 450	two door locker
CCK45452	1800 x 450 x 450	two door locker
CCK30303	1800 x 300 x 300	three door locker
CCK30453	1800 x 300 x 450	three door locker
CCK45453	1800 x 450 x 450	three door locker
CCK30304	1800 x 300 x 300	four door locker
CCK30454	1800 x 300 x 450	four door locker
CCK45454	1800 x 450 x 450	four door locker
CCK30306	1800 x 300 x 300	six door locker
CCK30456	1800 x 300 x 450	six door locker
CCK45456	1800 x 450 x 450	six door locker

Additional sizes available on request



elite

plastic lockers



- Strong lockers moulded in tough polyethylene
- Hard wearing material will not rust or corrode
- Supplied as standard with a padlock fitting or key operated lock



These stylish stackable plastic lockers are ideal for swimming pools, schools, commercial and industrial environments. Suitable for outside use, shielded from the weather conditions.

- Sloping top
- Harsh environment key cam lock
- Coin return lock for dry or wet environments
- Powder coated steel stands available



PRODUCT CODE	DESCRIPTION	SIZE H x W x D mm
ELSTLK01	Small Plastic locker	450 x 320 x 460
ELSTLK02	Medium Plastic Locker	600 x 320 x 460
ELSTLK03	Large Plastic Locker	900 x 320 x 460

Standard door colour options



All lockers supplied with mid grey carcass



Sloping Top

Prevents the build-up of debris and maintains a tidy and hygienic environment. Factory fitted.



Premium Mechanical Combination Lock

4 Digit mechanical combination lock with master key override. Additional security features. Master key sold separately.



Budget Mechanical Combination Lock

4 Digit mechanical combination lock with master key override. Master key sold separately.



Padlock Fitting type 1

Simple keyless locking solution. Clutch operation to improve security. Default padlock option for standard lockers.



Padlock Fitting type 2

Fixed cam bar operation. Ideal for younger users e.g. school lockers wanting a latch lock.



Master Key

Key Cam Lock, Mechanical Combination Locks, £1 Coin Return or Token Return Lock



seat & stand

- Welded 38mm tubular steel
- Durable powder coated paint finish
- Adjustable feet
- Supplied with two solid beech wood slats
- Locker raised 340mm minimum

PRODUCT CODE	WIDTH mm
LSS30	300
LSS45	450
LSS60	600
LSS90	900
LSS120	1200

The above sizes accept single or multiple lockers. Manufactured to suit various locker depths.

composite slats



Optional low water absorption composite slats. Ideal for environments where non porous surfaces are required e.g. the food industry. Price on application. Extended leadtime.

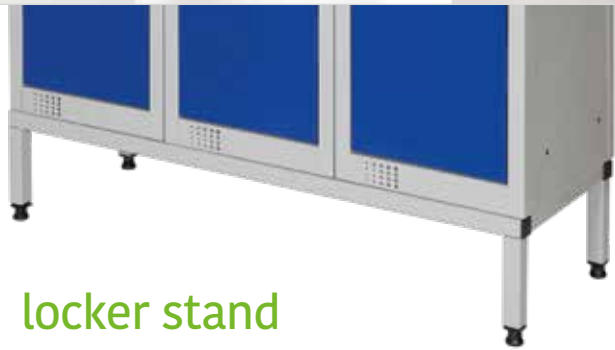

locker stand

- Welded 25mm tubular steel
- Powder coated to match locker carcass
- Adjustable feet
- Helps maintain a clean floor surface
- Locker raised 150mm

PRODUCT CODE	WIDTH mm
LS30	300
LS38	380
LS45	450
LS60	600
LS90	900
LS120	1200

The above sizes accept single or multiple lockers.
Manufactured to suit various locker depths.



garment hanging unit

900mm wide

PRODUCT CODE	DESCRIPTION
GHU45	Top cover & plinth (Excluding lockers)

Attaches to 450mm deep compartment lockers only

Electronic Combination Lock
4 digit user combination code with single and multiple user modes. Features a master service code.



Electronic rfid mifare Lock
Keyless locking solution with multiple user modes utilising wireless technology.



Vinyl Numbering
Numbered vinyl labels to help with locker allocation and identification. Black numeric print on white background.



Hanging Rail
Available as an alternative to a double coat hook. Ideal for 450mm deep lockers only. Factory fitted.



Key Fob
Numbered key fob to compliment vinyl numbering. Made from traffolyte material.



£1 Coin Return or Token Return lock. Factory Fitted.



Do you know



Steel manufactured standard height compartment lockers at 1800mm high are ideal for senior pupils and reduced height lockers at 1370mm are perfectly suited for younger primary aged children.

For those awkward areas with limited space there are also modular lockers that can be stacked and nested.

There is also a wide choice of coloured door options available to provide a mix of colours e.g. harlequin effect. Standard locker options help when wanting a 'bespoke' locker this includes locker stands, sloping tops, various lock options and complementary cloakroom equipment.

The following check list will give guidance when choosing the correct locker...

Establish the total requirement of compartments, remembering to incorporate potential additional users in the future. ✓

Consider the size of compartment needed e.g. clothes hanging requirement, size of kitbags/rucksacks, etc. Popular locker configurations within educational establishments are 2, 3 and 4 door lockers. ✓

Survey the premises to establish suitable locker locations that are dry, free from excessive moisture, remembering high traffic areas may not be suitable plus any areas exposed to the outdoor elements. ✓

Position lockers in areas that are open to view to assist with deterring vandalism ✓

Carefully consider a suitable locking mechanism, popular options are a key operated cam lock or a padlock fitting. Padlock fittings will accept a key or combination padlock. The minimum shank diameter recommended is 6mm. Additional keyless solutions are featured within the brochure. ✓

Allowing sufficient time from ordering lockers to having them installed. During busy periods of national holidays give as much notice as possible to arrange supply and delivery. ✓

Finally, consider acquiring necessary spare locker components to replace damaged parts e.g. doors, locks etc. Tip... a well maintained locker is less likely to be abused than an unmaintained locker. ✓

Remember to seek guidance from recommended locker suppliers who can offer expert advice on choice and installation. ✓

Excellent



elite

school cloakroom



PIS150DSB



PIS150SSB

Frame colour options



Mesh compartments and trays supplied in mid grey

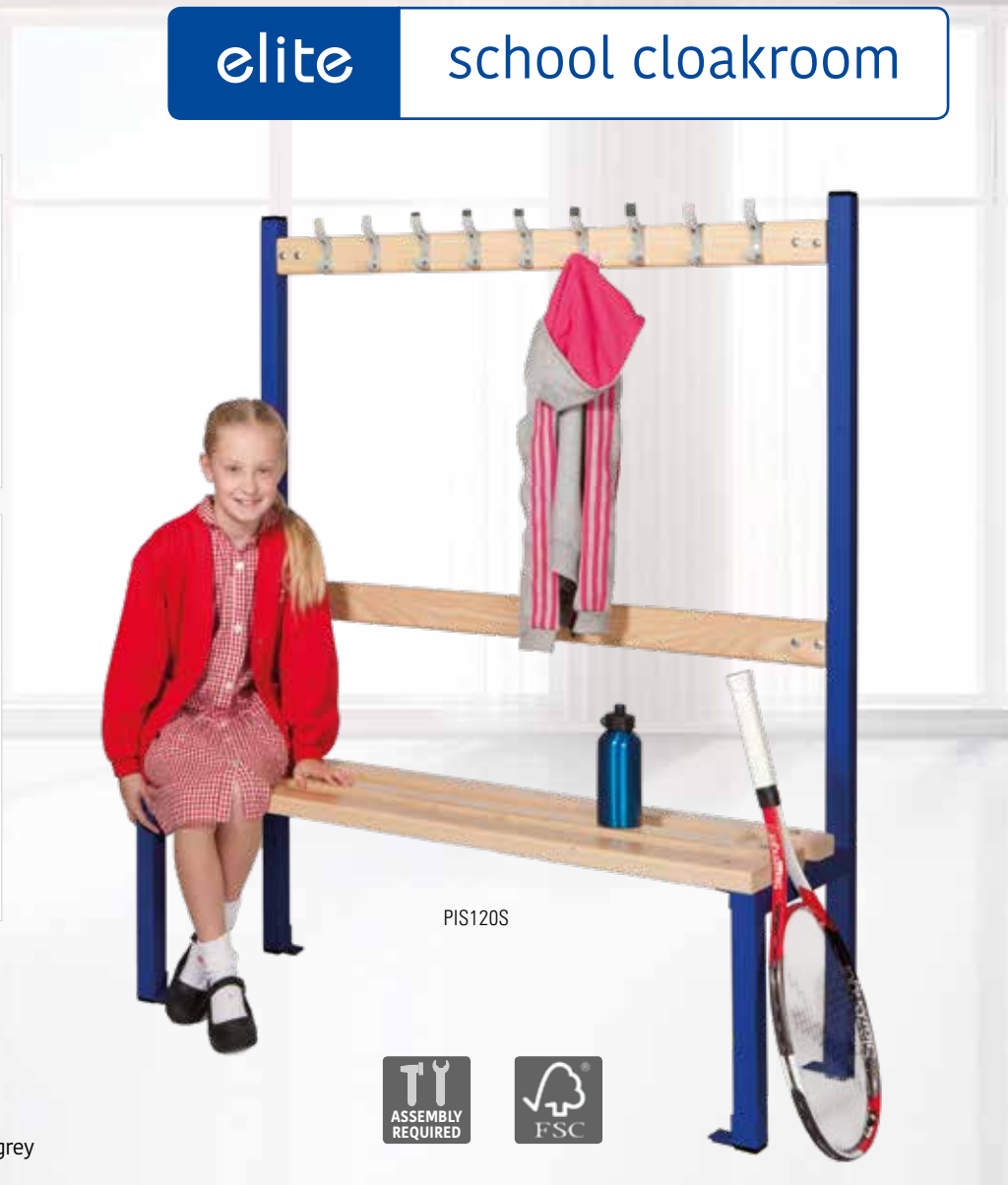

PIS120S



PIS120SSB



island seating

Single Sided Height 1370H x 400D mm

Beech wood slats. Back rest. Double coat hooks. Anti-bacterial powder coated paint finish. Optional extras - mesh shoe tray or compartments. Seat height 390 mm.

PRODUCT CODE	Length mm	Option	Coat Hooks
PIS120S	1200		9
PIS150S	1500		12
PIS120SST	1200	+ shoe tray	9
PIS150SST	1500	+ shoe tray	12
PIS120SSB	1200	+ 8 compartments	9
PIS150SSB	1500	+ 10 compartments	12

Island seating supplied flat packed - On-site assembly required

island seating

Double Sided Height 1370H x 760D mm

Beech wood slats. Back rest. Double coat hooks. Anti-bacterial powder coated paint finish. Optional extras - mesh shoe tray or compartments. Seat height 390 mm.

PRODUCT CODE	Length mm	Option	Coat Hooks
PIS120D	1200		18
PIS150D	1500		24
PIS120DST	1200	+ shoe tray	18
PIS150DST	1500	+ shoe tray	24
PIS120DSB	1200	+ 16 compartments	18
PIS150DSB	1500	+ 20 compartments	24

Island seating supplied flat packed - On-site assembly required



one door locker

- Special low height 1370mm high
- Cost savings if supplied nested
- Reinforced doors
- Lock options

PRODUCT CODE	SIZE H x W x D mm	SINGLE	NEST OF 2	NEST OF 3
1330301	1370 x 300 x 300	✓	✓	✓
1330381	1370 x 300 x 380	✓	✓	✓
1330451	1370 x 300 x 450	✓	✓	✓

Supplied with a shelf and double coat hook

two door locker

- Special low height 1370mm high
- Sloping top option
- Reinforced doors
- Lock options

PRODUCT CODE	SIZE H x W x D mm	SINGLE	NEST OF 2	NEST OF 3
1330302	1370 x 300 x 300	✓	✓	✓
1330382	1370 x 300 x 380	✓	✓	✓
1330452	1370 x 300 x 450	✓	✓	✓

Supplied with a double coat hook in each compartment



three door locker

- Special low height 1370mm high
- Reinforced doors
- Lock options
- Perforated door option

PRODUCT CODE	SIZE H x W x D mm	SINGLE	NEST OF 2	NEST OF 3
1330303	1370 x 300 x 300	✓	✓	✓
1330383	1370 x 300 x 380	✓	✓	✓
1330453	1370 x 300 x 450	✓	✓	✓

Supplied with no internal fittings

Standard door colour options



All lockers supplied with mid grey carcass



quarto locker

- Ideal modular storage solution in difficult areas
- Pre-drilled for nesting
- Lock options available
- Reinforced doors
- Perforated door option

PRODUCT CODE	SIZE H x W x D mm
513045QU	512 x 300 x 450

Supplied with no internal fittings

Standard door colour options



All lockers supplied with mid grey carcass



cube lockers

- Ideal for utilising awkward areas
- Can be stacked or nested
- Three sizes 300, 380 & 450mm
- Lock options available

PRODUCT CODE	SIZE - H x W x D mm
303030C	300 x 300 x 300
383838C	380 x 380 x 380
454545C	450 x 450 x 450

Supplied with no internal fittings



island seating

- Welded 38mm tubular steel
- Supplied with double coat hooks and beech wood slats
- Mesh compartments and tray options available
- Anti-bacterial powder coated
- Floor fixing bracket
- Optional composite slats

single sided

PRODUCT CODE	SIZE H x L x D mm	NUMBER OF HOOKS
IS120S	1800 x 1200 x 400	9
IS150S	1800 x 1500 x 400	12

double sided

PRODUCT CODE	SIZE H x L x D mm	NUMBER OF HOOKS
IS120D	1800 x 1200 x 760	18
IS150D	1800 x 1500 x 760	24

single sided plus shoe compartments

PRODUCT CODE	SIZE H x L x D mm	NUMBER OF HOOKS
IS120SSB	1800 x 1200 x 400	9
IS150SSB	1800 x 1500 x 400	12

double sided plus shoe compartments

PRODUCT CODE	SIZE H x L x D mm	NUMBER OF HOOKS
IS120DSB	1800 x 1200 x 760	18
IS150DSB	1800 x 1500 x 760	24

single sided plus shoe tray

PRODUCT CODE	SIZE H x L x D mm	NUMBER OF HOOKS
IS120SST	1800 x 1200 x 400	9
IS150SST	1800 x 1500 x 400	12

double sided plus shoe tray

PRODUCT CODE	SIZE H x L x D mm	NUMBER OF HOOKS
IS120DST	1800 x 1200 x 760	18
IS150DST	1800 x 1500 x 760	24

Island seating supplied flat packed, simple on-site assembly required
Seat height 390 mm

Frame colour options



Mesh compartments and trays supplied in mid grey



IS120D



IS120SST





IS150DSB



IS120D



Optional low water absorption composite slats, ask for details.



elite

bench seating

- Welded 38mm tubular steel
- Supplied with three beech wood slats
- Free-standing
- Optional composite slats
- Supplied assembled

bench seating

390 H x 300 D mm

PRODUCT CODE	SIZE LENGTH mm
BS60	600
BS90	900
BS120	1200
BS150	1500
BS180	1800



BS180

Floor anchor feet available on request. Supplied assembled.



724818CSC



722418CSC



dangerous substance cabinets

PRODUCT CODE	SIZE H x W x D mm	SHELVES	SUMP CAPACITY	SLOPING TOP	3 POINT LOCKING
724818CSC	1830 x 1220 x 457	3	45 Ltr		✓
723618CSC	1830 x 915 x 457	3	36 Ltr	Option	✓
722418CSC	1830 x 610 x 457	3	20 Ltr	Option	✓
603618CSC	1525 x 915 x 457	2	36 Ltr	Option	✓
483618CSC	1220 x 915 x 457	2	36 Ltr	Option	✓
393618CSC	1000 x 915 x 457	1	30 Ltr	Option	✓
361818CSC	910 x 457 x 457	1	15 Ltr		✓
283618CSC	710 x 915 x 457	1	30 Ltr	Option	✓

mini dangerous substance cabinets

PRODUCT CODE	SIZE H x W x D mm	SHELVES	SUMP CAPACITY	SLOPING TOP	3 POINT LOCKING
243618CSC	610 x 915 x 457	1	30 Ltr	Option	✓
243615CSC	610 x 915 x 381	1	15 Ltr		✓
301818CSC	760 x 457 x 457	1	10 Ltr		
281812CSC	710 x 457 x 305	1	10 Ltr		
281412CSC	710 x 355 x 305	1	5 Ltr		
241818CSC	610 x 457 x 457	1	10 Ltr		
181812CSC	457 x 457 x 305	1	5 Ltr		

IMPORTANT NOTICE : In accordance with HSE guidelines and regulations, before these cabinet are placed into operational use, it is the responsibility of the user to ensure that : the signage to be displayed on this cabinet is appropriate to the hazards associated with those chemicals or products to be stored within.

GHS signage will be supplied on dangerous substance cabinets, the primary label is the Flame meaning 'Flammable'....



Additional GHS signage supplied loose includes 'Oxidizing' and 'Explosive'.....



Signage labels are easy peel type to allow switching of the primary label. Additional GHS signage information supplied within each cabinet.

Stands with adjustable feet

PRODUCT CODE	SIZE H x W x D mm
3618STCSC	533 x 915 x 457
1818STCSC	533 x 457 x 457



724818CSC



723618CSC



722418CSC



603618CSC



483618CSC



393618CSC



361818CSC



301818CSC



723618CSC

These robust metal cabinets have been designed to offer good structural stability and safely contain spillages within the cabinets leak proof sump.

Suitable for the secure storage of chemicals, paints, solvents and dangerous substances as classified by CHIP and the new CLP regulation.

Each unit is supplied with a choice of additional signage plus chemical segregation information.

Conforms to Health & Safety Executive Guide HSG51 and DSEAR 2002.

- GHS labelling
- Powder coated paint finish, hi-vis yellow
- Reinforced doors
- Leak proof sump
- 3 point locking

Specification: Manufactured using high quality steel 0.7mm - 1.1mm for extra rigidity and to maintain structural integrity under extreme conditions. Doors are reinforced with steel door stiffeners. Welded leak proof base sump. Supplied with adjustable shelves. Sloping tops and stands available. Powder coated paint finish. Mastered locks supplied with 2 keys. Shelf loading 60kg UDL (uniformly distributed load). These products are not fire proof.

dangerous substance stackable cabinets

PRODUCT CODE	SIZE H x W x D mm	SHELVES	SUMP CAPACITY	SLOPING TOP	3 POINT LOCKING
283618CSCCK	710 x 915 x 457	1	30 Ltr		✓
243618CSCCK	610 x 915 x 457	1	30 Ltr		✓

243618CSCCK

dangerous substance wall mounted cabinets

PRODUCT CODE	SIZE H x W x D mm	SHELVES	SUMP CAPACITY	SLOPING TOP	3 POINT LOCKING
243615CSCCW	610 x 915 x 381	1	15 Ltr		✓
203618CSCCW	480 x 915 x 457	1	20 Ltr	Option	✓

283618CSCCK



243615CSCCW



sloping top add-on

PRODUCT CODE	SIZE H x W x D mm
4818STU	150 x 1220 x 457
3618STUCSC	150 x 915 x 457
2418STUCSC	150 x 610 x 457



3618STCSC



283618CSCCK



283618CSC



281812CSC



281412CSC



243618CSCCK



243618CSC



243615CSC



241818CSC



181812CSC



724818COS*



723618JANCOS*

coshh cabinets

PRODUCT CODE	SIZE H x W x D mm	SHELVES	SUMP CAPACITY	SLOPING TOP	3 POINT LOCKING
724818COS*	1830 x 1220 x 457	3	45 Ltr		✓
723618COS	1830 x 915 x 457	3	36 Ltr	Option	✓
722418COS	1830 x 610 x 457	3	20 Ltr	Option	✓
483618COS	1220 x 915 x 457	2	36 Ltr	Option	✓
393618COS	1000 x 915 x 457	1	30 Ltr	Option	✓
361818COS	910 x 457 x 457	1	15 Ltr		✓
283618COS	710 x 915 x 457	1	30 Ltr	Option	✓

mini coshh cabinets

243615COS	610 x 915 x 381	1	15 Ltr		✓
301818COS	760 x 457 x 457	1	10 Ltr		
281812COS	710 x 457 x 305	1	10 Ltr		
241818COS	610 x 457 x 457	1	10 Ltr		
181812COS	457 x 457 x 305	1	5 Ltr		

janitorial coshh cabinet

723618JANCOS*	1830 x 915 x 457	3	15 Ltr	Option	✓
---------------	------------------	---	--------	--------	---

*Supplied with 'Guidance on GHS labelling notice'

GHS signage will be supplied on Coshh cabinets, the primary label is the Exclamation Mark meaning 'Harmful/Irritant'...



Additional GHS signage supplied loose includes 'Health Hazard', 'Acute Toxicity', 'Corrosive' and 'Aquatic Toxicity'.....



Signage labels are easy peel type to allow switching of the primary label. Additional GHS signage information supplied within each cabinet.

coshh stackable cabinet

PRODUCT CODE	SIZE H x W x D mm	SUMP CAPACITY	SLOPING TOP	3 POINT LOCKING
283618COSK	710 x 915 x 457	1	30 Ltr	✓

stands with adjustable feet

3618STCOS	533 x 915 x 457
1818STCOS	533 x 457 x 457

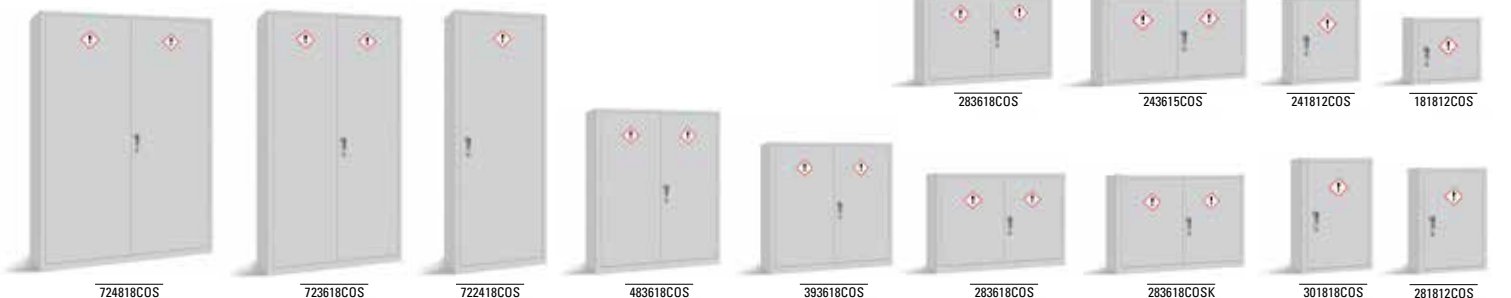



722418COS



361818COS

723618COS



393618COS

Control of Substances Hazardous to Health Regulations apply to virtually all UK workplaces. There are mandatory requirements for employers to carry out coshh risk assessments. Substances hazardous to health are those products that are capable of causing adverse effects or disease arising out of exposure from work activities. It is the employers responsibility to gather information on these products and either eradicate the risk or at least control it. Hazardous substances are those chemicals classified by CHIP and the new CLP regulation. Coshh and Acid cabinets are manufactured to the same specification as dangerous substance cabinets.

elite

acid cabinets

acid cabinets

PRODUCT CODE	SIZE H x W x D mm	SHELVES	SUMP CAPACITY	SLOPING TOP	3 POINT LOCKING
723618AC	1830 x 915 x 457	3	36 Ltr	Option	✓
393618AC	1000 x 915 x 457	1	30 Ltr	Option	✓
361818AC	910 x 457 x 457	1	15 Ltr		

mini acid cabinets

283618AC	710 x 915 x 457	1	30 Ltr
301818AC	760 x 457 x 457	1	10 Ltr
281812AC	710 x 457 x 305	1	10 Ltr

GHS signage will be supplied on Acid cabinets, the primary label is 'Corrosion'....

Additional GHS signage supplied loose includes 'Aquatic Toxicity', and 'Harmful/Irritant'.....

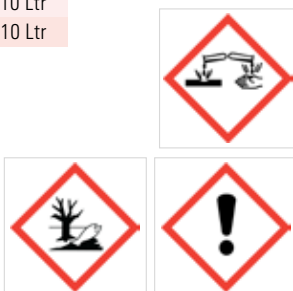

Signage labels are easy peel type to allow switching of the primary label. Additional GHS signage information supplied within each cabinet.



723618AC

361818AC

IMPORTANT NOTICE : In accordance with HSE guidelines and regulations, before these cabinets are placed into operational use, it is the responsibility of the user to ensure that : the signage to be displayed on this cabinet is appropriate to the hazards associated with those chemicals or products to be stored within. Not suitable for the storage of sulphuric acid, nitric and hydrochloric acids.



ST202415CSC



ST244618CSC



IMPORTANT NOTICE: In accordance with HSE guidelines and regulations, before these cabinet are placed into operational use, it is the responsibility of the user to ensure that : the signage to be displayed on this cabinet is appropriate to the hazards associated with those chemicals or products to be stored within.

GHS signage will be supplied on dangerous substance floor chests, the primary label is the Flame meaning 'Flammable'...



Additional GHS signage supplied loose includes 'Oxidizing' and 'Explosive'.....



Signage labels are easy peel type to allow switching of the primary label. Additional GHS signage information supplied within each floor chest.

▲ dangerous substance sloping top floor chest

PRODUCT CODE	SIZE H x W x D mm	SUMP CAPACITY	LOCK TYPE
ST244618CSC	610/540 x 1170 x 457	35 Ltr	Hasp & Staple
ST202415CSC	510/450 x 610 x 381	15 Ltr	Hasp & Staple

Manufactured with an integral seam welded leak proof base sump.

▼ dangerous substance flat top floor chest

PRODUCT CODE	SIZE H x W x D mm	SUMP CAPACITY	LOCK TYPE
FT244618CSC	610 x 1170 x 457	35 Ltr	Hasp & Staple
FT202413CSC	510 x 610 x 330	15 Ltr	Hasp & Staple

Manufactured with an integral seam welded leak proof base sump.



FT202413CSC



FT244618CSC



Robust cabinets constructed using 1.2mm 304 grade stainless steel (food standard) suitable for use in environments that demand high levels of hygiene. Supplied with a selection of GHS signage to personalise the cabinet to suit the contents.



- Practical hygienic storage solution
- Products are able to withstand hosing down or use of a pressure washer
- Sloping tops and stands available

GHS signage will be supplied on these cabinets, the primary label is the Flame meaning 'Flammable'....



Additional GHS signage supplied loose includes 'Oxidizing', 'Harmful/Irritant', 'Explosive', 'Acute Toxicity', 'Corrosive' and 'Aquatic Toxicity'.....



stainless steel hazardous cabinets

PRODUCT CODE	SIZE H x W x D mm	SHELVES	SUMP CAPACITY	SLOPING TOP	3 POINT LOCKING
CCK884CH	1800 x 900 x 450	3	36 Ltr	Option	✓
CCK984CH	900 x 900 x 450	2	15 Ltr	Option	✓



GBS



GHS signage will be supplied on these bin units, the primary label is the Flame meaning 'Flammable'....



Additional GHS signage supplied loose includes 'Oxidizing' and 'Explosive'.....



Signage labels are easy peel type to allow switching of the primary label. Additional GHS signage information supplied within each bin.

galvanised bin units

PRODUCT CODE	SIZE H x W x D mm	SUMP CAPACITY	LOCK TYPE
GB	765 x 685 x 508	N/A	Hasp & Staple
GBS	765 x 685 x 508	40 Ltr	Hasp & Staple

Signage as shown. Suitable for external use. Constructed from galvanised sheet with an optional seam welded leak proof sump.



GB



723618JAN



723618C



361818C



393618SEC

723618SEC

Standard door colour options



All cupboards supplied with mid grey carcass

- Ideal for commercial/industrial storage solutions
- Robust steel construction
- 3 point security locking*
- Welded frame with reinforced doors
- Supplied ready assembled
- Shelf loading 60kg UDL
- Hasp & staple lock option available

cupboards - workstation -janitorial

PRODUCT CODE	SIZE H x W x D mm	SHELVES	DESCRIPTION
723618C	1830 x 915 x 457	3	Standard
723618CE	1830 x 915 x 457	4	Clothing & Equipment
723618JAN	1830 x 915 x 457	4	Janitorial
723618W	1830 x 915 x 457	1	Wardrobe
393618C	1000 x 915 x 457	1	Small double door
361818C	910 x 457 x 457	2	Small single door
723618SEC	1830 x 915 x 457	3	Large Security*
393618SEC	1000 x 915 x 457	1	Small Security*
MDK1	1066/1200 x 915 x 457	1	Workstation (single drawer)
MDK2	1066/1200 x 915 x 457	1	Workstation (two drawer)
MDK3	2 x Brake & 2 x Swivel		Mobile Base (for Workstation)
361818DT	925 x 457 x 457	1	Tool locker plus recessed top



723618CE



MDK1



361818DT

*Supplied with a hasp and staple fitting. *361818C plus 361818DT single point locking

- Robust, reinforced double door steel cabinet
- Choice of three bin configurations
- Multiple coloured bins supplied with identity label
- Secure 3 point locking
- Durable powder coated paint finish
- Maximum total loading 160kg



Standard door colour options



All cupboards supplied with mid grey carcass

small part storage cupboards

PRODUCT CODE	BIN REF	BINS	BIN SIZE H x W x D mm	BIN COLOUR
723618LVKIT1	Size 3	30	120 x 144 x 235	Blue
	Size 4	12	163 x 205 x 345	Red
723618LVKIT2	Size 2	28	75 x 105 x 160	Yellow
	Size 3	20	120 x 144 x 235	Blue
723618LVKIT3	Size 3	12	163 x 205 x 345	Red
	Size 4	32	163 x 205 x 345	Red

All cabinets 1830H x 915W x 457D mm

Container bins manufactured from PEHD. Acid, Oil & Solvent resistant



723618LVKIT1



723618LVKIT2



723618LVKIT3

mesh fronted/stock control cupboards

- Ideal for use in securing expensive stock under controlled conditions
- Lockable mesh doors to allow easy visual inspection of contents.
- Supplied with adjustable shelving.
- Doors reinforced with steel profiles for extra security
- 3 point locking, supplied with 2no. keys. Mastered lock.
- Shelf loading 60kg UDL.

PRODUCT CODE	SIZE H x W x D mm	SHELVES
393618CMESH	1000 x 915 x 475	1
723618CMESH	1830 x 915 x 475	3
723618CEMESH	1830 x 915 x 475	4

Standard door colour options



All cupboards supplied with mid grey carcass



393618CMESH

723618CMESH

723618CEMESH



724818C

- Supplied fully assembled
- 3 point locking
- Welded frame construction for extra strength and rigidity
- Shelf loading 60kg with a uniformly distributed load

Range of extra wide cupboards to offer greater storage capacity under secure conditions. Choice of internal configurations and door colour options. These high volume cupboards are 1220 mm wide. All cupboards are 1830h x 457d mm.

Standard door colour options



All cupboards supplied with mid grey carcass

extra wide standard cupboard

PRODUCT CODE SIZE H x W x D mm
724818C 1830 x 1220 x 457

Complete with 3no. adjustable shelves

extra wide clothing and equipment cupboard

PRODUCT CODE SIZE H x W x D mm
724818CE 1830 x 1220 x 457

Adjustable compartments with central divider and hanging rail plus hooks

extra wide janitorial cupboard

PRODUCT CODE SIZE H x W x D mm
724818JAN 1830 x 1220 x 457

Secure storage facility for cleaning equipment supplies.

extra wide wardrobe cupboard

PRODUCT CODE SIZE H x W x D mm
724818W 1830 x 1220 x 457

Adjustable shelves fitted with a hanging rail.



724818JAN



724818CE



724818W



722418C



722418N



Modular sloping top

- Steel construction with a welded frame
- Reinforced doors with 3 point locking plus 2 keys
- Supplied with galvanised internal fittings.
- Sloping top option
- Supplied fully assembled

slim general storage

PRODUCT CODE SIZE H x W x D mm

722418C 1830 x 610 x 457

Complete with 3no. adjustable shelves, 60 Kg loading UDL

slim clothing cupboard

PRODUCT CODE SIZE H x W x D mm

722418CD 1830 x 610 x 457

Clothing cupboard with central divider and hanging rails plus hooks

slim clothing and equipment cupboard

PRODUCT CODE SIZE H x W x D mm

722418N 1830 x 610 x 457

Hanging compartment with rail plus hooks.
Additional storage compartments ideal for personal possessions.

slim wardrobe cupboard

PRODUCT CODE SIZE H x W x D mm

722418W 1830 x 610 x 457

Adjustable shelf fitted with a hanging rail.
UDL- Uniformly Distributed Load.



722418CD



722418W



FAMDK2



FA723618



FA722418



FA361818



FA30

FA38

MEDICAL CABINETS... floorstanding. Reinforced doors. Complete with adjustable shelves. Choice of three sizes.

FIRST AID WORKSTATION... ideal unit for positioning close to work activities in remote areas of factories and businesses etc. Provides lockable secure storage for small and bulky items. Useful raised sloping desk top. Mobile base option available.

CUBE LOCKER... ideal for localised storage. Units available in three sizes and can be wall mounted. Fixings not supplied. Escutcheon plate to apply vinyl numbering.

first aid cabinets

PRODUCT CODE	SIZE H x W x D mm	SHELVES	DESCRIPTION
FA723618	1830 x 915 x 457	3	Two door cabinet
FA722418	1830 x 610 x 457	3	One door cabinet
FA393618	1000 x 915 x 457	1	Two door cabinet
FA361818	910 x 457 x 457	2	One door cabinet
FA30	300 x 300 x 300		Cube locker
FA38	380 x 380 x 380		Cube locker
FA45	450 x 450 x 450		Cube locker
FAMDK2	1066/1200 x 915 x 457	2	First aid workstation
FAMDK3	130 x 915 x 457		Workstation mobile base

Supplied with galvanised internal fittings.

Mobile base supplied with 2 x brake, 2 x swivel castors.



elite

ppe cabinets

- 3 point security locking*
- Galvanised internal components
- Labelled 'Personal Protective Equipment'
- Supplied fully assembled



PPE723618CE

Standard door colour option



All cupboards supplied with mid grey carcass



PPE723618C

clothing & equipment cabinet

PRODUCT CODE	SIZE - H x W x D mm
PPE723618CE	1830 x 915 x 457

Supplied with a vertical hanging compartment plus individual storage compartments

general storage cabinet

PRODUCT CODE	SIZE - H x W x D mm
PPE723618C	1830 x 915 x 457

Supplied with three adjustable shelves

wardrobe cabinet

PRODUCT CODE	SIZE - H x W x D mm
PPE723618W	1830 x 915 x 457

Supplied with an adjustable top shelf fitted with hanging rail



PPE723618W



All cabinets labelled with 'Personal Protective Equipment'

double door cabinet

PRODUCT CODE	SIZE - H x W x D mm
PPE393618C	1000 x 915 x 457

Complete with one adjustable shelf

single door cabinet

PRODUCT CODE	SIZE - H x W x D mm
PPE361818C	910 x 457 x 457

Complete with two adjustable shelves.
*Single point locking



724518RED1

- High density secure storage of small valuable items
- 3 point locking & reinforced doors
- Ideal for central distribution of internal mail under controlled conditions
- Choice of three tray sizes: 75, 150 and 225mm high. All trays 312w x 427dmm
- Coloured tray options Opaque, Red and Blue
- 5kg loading per tray

Unique and exclusive product offering... a high density removable tray storage solution that helps to dispense and segregate valuable smaller sized items within a secure lockable cupboard. Supplied with robust polypropylene trays in a three column configuration.

Each tray can be fully extracted to allow the transfer of multiple items safely to a remote working location.



See video showing product features and specification

Standard door colour options



All cupboards supplied with mid grey carcass



724518BLUE3



Application example...

- Multiple compartment tray storage solution where items can be securely stored away from a dirty environment.
- Businesses and organisations operating a 'clear desk' or a 'shared desking' policy.
- Document and mail sorting.



724518OPA2

high capacity storage cupboards

PRODUCT CODE	TRAYS	TRAY DESCRIPTION	TRAY COLOUR
724518OPA1	51	Shallow 75mm	Opaque
724518RED1	51	Shallow 75mm	Red
724518BLUE1	51	Shallow 75mm	Blue
724518OPA2	27	Deep 150mm	Opaque
724518RED2	27	Deep 150mm	Red
724518BLUE2	27	Deep 150mm	Blue
724518OPA3	18	Extra Deep 225mm	Opaque
724518RED3	18	Extra Deep 225mm	Red
724518BLUE3	18	Extra Deep 225mm	Blue

All cupboards 1830h x 1120w x 457d mm. Trays and runners are delivered separately from the cupboard and require fitting on site. Trays manufactured from polypropylene.

- Secure and flexible storage solution for large and small item storage
- Ideal for use in classrooms
- Provides two upper storage levels complete with one adjustable shelf
- Reinforced doors with 3 point locking
- Supplied with Gragnells trays, manufactured from extra strong polypropylene

tray storage/teachers cupboards

PRODUCT CODE	TRAYS	TRAY DESCRIPTION	TRAY COLOUR
724518OPA12	12	Extra Deep 225mm	Opaque
724518RED12	12	Extra Deep 225mm	Red
724518BLUE12	12	Extra Deep 225mm	Blue
724518YELL12	12	Extra Deep 225mm	Yellow
724518OPA18	18	Deep 150mm	Opaque
724518RED18	18	Deep 150mm	Red
724518BLUE18	18	Deep 150mm	Blue
724518YELL18	18	Deep 150mm	Yellow
724518OPA30	30	Shallow 75mm	Opaque
724518RED30	30	Shallow 75mm	Red
724518BLUE30	30	Shallow 75mm	Blue
724518YELL30	30	Shallow 75mm	Yellow

All cupboards 1830H x 1120W x 457D mm.
 All trays 312w x 427d mm.
 Trays and runners delivered separately from the cupboard.



724518OPA18

Standard door colour options



All cupboards supplied with mid grey carcass



724518RED30



724518BLUE12

Locker Specification 1800/1950h x 380w x 450d mm. Three door locker with a sloping top and a special postal slot in the door. Supplied with a 4 digit mechanical combination lock and special paint finish

Industry Commercial offices, London and Birmingham

Clients Brief "To supply a custom made locker to accept internal mail and provide sufficient storage for personal belongings. Must be keyless locking. Locker finish to complement modern office surroundings"

Special Feature(s) Manufactured in a special width of 380mm. Doors incorporate a postal slot and a 4 digit mechanical combination lock. Special non-standard colour paint finish applied.

Highlighted on these pages is a showcase of non-standard products that have been manufactured to satisfy specific client requests to manufacture a custom made product.

The featured products illustrate apart from the comprehensive range of standard products, it is possible to incorporate custom features that are either intended to complement the immediate surroundings or to suit the special needs of users.

These features are typically special colours and finishes, the use of special locks, non-standard sizes to maximise awkward spaces and the use of colours for harlequin effects.' Ask the sales representative for details.



Locker Specification 1800 & 1370h x 300w x 450d mm. Two door locker supplied with a padlock fitting. Special combination of coloured doors.

Industry Education, primary school

Clients Brief "Provide a storage solution to the problem of having cluttered corridors of jackets and bags plus incorporate a special theme of colours"

Special Feature(s) Supplied both standard and special sized lockers to maximise limited wall space. Fitted with a padlock fitting to act as a latch lock. Manufactured in a special configuration of coloured doors to give a special effect once installed.

Cupboard Specification 1830h x 1120w x 457d mm. Modified High Capacity Storage Cupboard for bulk storage and removable tray storage.

Industry Education, Export.

Clients Brief "A requirement for a flexible storage solution for both bulky items and student's personal work within classrooms"

Special Feature(s) A customised standard product...the high capacity storage cupboard. Redesigned to accept adjustable shelving plus worktop in the upper section while retaining the individual tray storage facility in the lower section.

Locker Specification 1800h x 225w x 450d mm. Two door locker supplied with a 4 digit mechanical combination lock with master key over-ride.

Industry Drinks bottling plant

Clients Brief "To maximise the available floor area to provide as many compartments as possible suitable for hanging garments"

Special Feature(s) Manufactured to a special width of 225mm to form a slim locker. Presented a keyless solution with master key over-ride.



Locker Specification 1800/1950h x 300w x 450d mm. Two door locker with a sloping top and shoe compartment within the main hanging compartment. Key cam lock.

Industry Food preparation

Clients Brief "To maximise compartment space for shoe storage within the same footprint of a standard locker"

Special Feature(s) Features an extra shelf to form a shoe compartment within a standard sized locker.



Locker Specification 1800h x 600w x 450d mm. Special 14no. compartment unit

Industry Retail Bank, Export.

Clients Brief "Design a locker that allows a choice of compartment sizes within a single unit to temporarily store personal items where entry into a bank with bags is prohibited"

Special Feature(s) Presented a unit with 14no. compartments in total, 8no. of a smaller sized compartment in the top half and 6no. larger in the lower half.



Locker Specification 1800h x 300w x 450d mm. Six door locker supplied with a key cam lock. Special door colours and configuration to give a harlequin effect.

Industry Sponsored Corporate events

Clients Brief "Provide a special configuration of corporate colours to give a lasting effect to create brand loyalty"

Special Feature(s) Supplied a standard sized locker to offer high density storage that offered value for money and a convenient storage solution with a harlequin effect of special corporate colours.



Locker Specification 1800h x 225w x 450d mm. Six door locker supplied with a key cam lock and special door colour

Industry Retail

Clients Brief "Provide multi compartment storage within the limited floor space for staff to store small personal possessions"

Special Feature(s) Manufactured to a special width of 225mm to form a slim six door locker and clients own choice of coloured door.

Locker specification All compartment lockers.
 Industry All industries
 Clients Brief "Investigate the feasibility of a steel locker with a wood effect finish to compete with traditional expensive wood lockers."
 Special Feature(s) Worked closely with a specialist supplier of powder coated finishes. Trials were carried out using a unique formulation to give a quality grained wood effect finish that can withstand severe misuse. Still in development.

Locker Specification 1800h x 300w x 450d mm three door locker with a laminate door and sloping top. Fitted with a type 1 padlock fitting.
 Industry Educational.
 Clients Brief "Required a multi compartment locker that can offer a robust design featuring a rebated door to guard against mis-use."
 Special Feature(s) Incorporates a sloping top to help prevent storage outside the locker. Clutch type padlock to prevent mis-use of the lock. Supplied with an all black carcass with a Fundermax Arctic Punto door finish. The material thickness of the door was 12mm and was manufactured to accept engraved numbering discs for locker identification.



Seat & Stand specification Locker accessories
 Industry Food and medical industries
 Clients Brief "Source a non-porous material for use with seat and stands to complement a new locker changing room facility."
 Special Feature(s) Offered a solid grade laminate material in place of Beech wood slats. Laminate material is available in many colours and finishes, is hardwearing, easy to clean and is resistant to moisture ingress.

Important factors to consider on locker room design and choice of locker.

The size and choice of the locker compartment type will be determined by the items to be stored e.g. the need to hang garments, size of bags/ holdalls, the storage of motor cycle helmets and footwear etc. There may be a need to keep workwear separately from personal clothing.

If hygiene is important consider a factory fitted sloping top option on lockers. This prevents an unwanted build up of dirt and debris and also encourages storage within the locker and not on top of the locker. Locker stands will raise the locker off the floor to provide cleaning access and clear of harmful floor cleaning chemicals.

In dry changing room environments lockers can be floor mounted. In wet areas it is important to raise the locker off the floor using locker stands.

Check floor surfaces are level, lockers are designed to be floor standing. To overcome uneven floors locker stands are supplied with adjustable feet.

If users are changing footwear, it would be useful to offer bench seating or an integral seat and stand option.

If there is a need to air damp clothing - then consider lockers where compartments are big enough to hang garments. Also consider perforated holes in doors to increase air circulation.

Consider the type of lock carefully, the choices are.... key cam lock, padlock type fitting, £1 coin return or token return lock, 4 digit combination locks and electronic rfid locks. Remember during installation to database keys to a locker compartment for easier key management.

Consider additional locker accessories, e.g. hanging rail, vinyl numbering, extra keys, master keys etc.

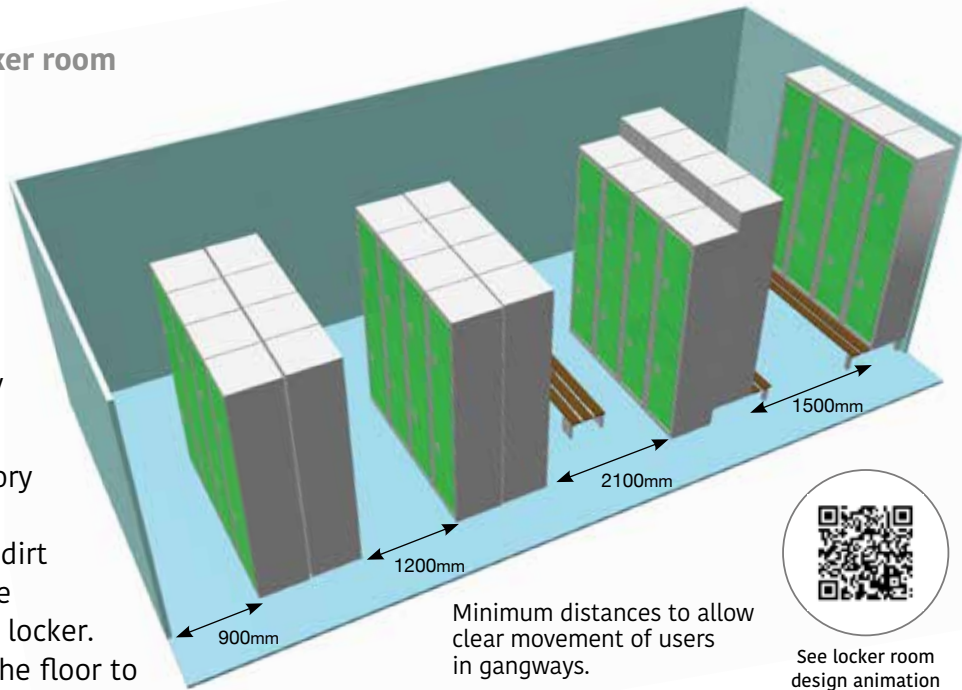

Is there a need for locker compartments to be visually monitored? vision panel doors allow inspection from outside of the locker.

Finally, it is important to consider the factors relating to the delivery of lockers and their installation e.g. how best to manage the removal of old lockers and the contents of the compartments, delivery access – vehicle size restrictions, can the installation be carried out during normal working hours. The availability of suitable handling and lifting equipment, remembering nested lockers are more difficult to handle than single lockers.

General Information

Metal lockers are not intended for use in damp or wet areas. Under the Workplace (Health, Safety and Welfare regulations 1992) employers are required to provide suitable and sufficient accommodation for workwear and personal clothing. The Personal Protective Equipment at work regulations 1992 also require the provision of suitable storage to protect personal protective equipment from damage, contamination or loss.

single door lockers



- A 270/1410h x 235w x 275d
- B 270/1410h x 235w x 425d
- C 270/1410h x 385w x 425d

two door lockers

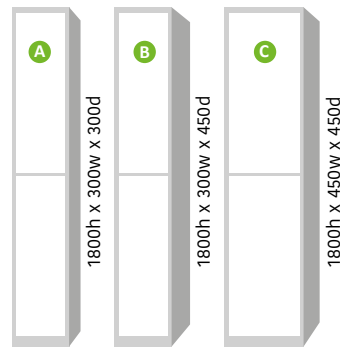

- A 835h x 235w x 275d
- B 835h x 235w x 425d
- C 835h x 385w x 425d

three door lockers

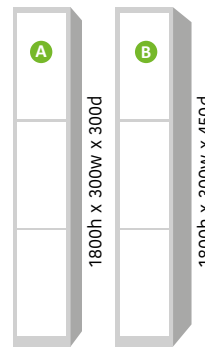

- A 540h x 235w x 275d
- B 540h x 235w x 425d

four door lockers



- A 400h x 235w x 275d
- B 400h x 235w x 425d
- C 400h x 385w x 425d

five door lockers

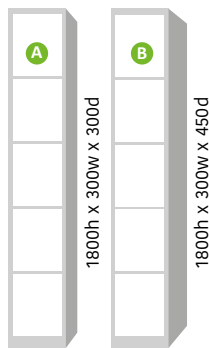

- A 310h x 235w x 275d
- B 310h x 235w x 425d

six door lockers

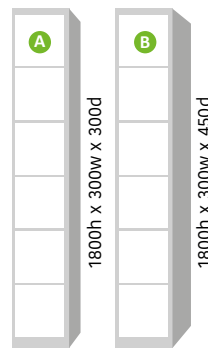

- A 260h x 235w x 275d
- B 260h x 235w x 425d

eight door lockers

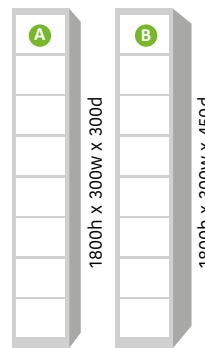

- A 185h x 235w x 275d
- B 185h x 235w x 425d

personal effects lockers

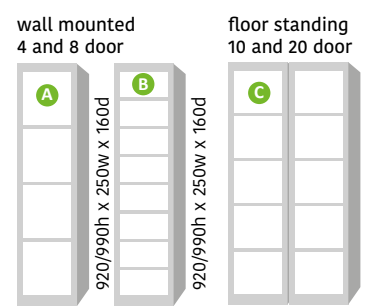

- A 180h x 190w x 135d
- B 75h x 190w x 135d
- C 150h x 165w x 355d

combi locker

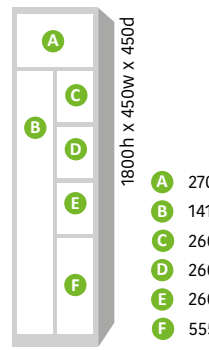

- A 270h x 385w x 425d
- B 1410h x 175w x 425d
- C 260h x 190w x 425d
- D 260h x 190w x 425d
- E 260h x 190w x 425d
- F 555h x 190w x 425d

clean & dirty locker

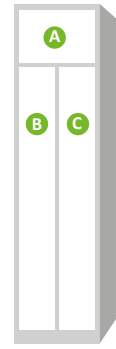

- A 270h x 385w x 425d
- B 1410h x 175w x 425d
- C 1410h x 175w x 425d

two person locker

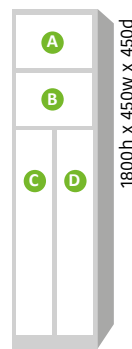

- A 200h x 385w x 425d
- B 180h x 385w x 425d
- C 1250h x 175w x 425d
- D 1250h x 175w x 425d

twin locker

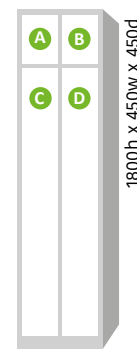

- A 270h x 175w x 425d
- B 270h x 175w x 425d
- C 14100h x 175w x 425d
- D 1410h x 175w x 425d

school lockers



- A 200/1050h x 235w x 275/355/425d
- B 630h x 235w x 275/355/425d
- C 400h x 235w x 275/355/425d

cube lockers

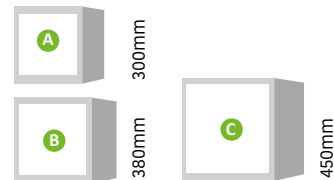

- A 250h x 240w x 280d
- B 330h x 315w x 360d
- C 400h x 385w x 430d

quarto locker

- A 400h x 235w x 425d

garment lockers



- A 1710h x 280w x 425d
- B 320h x 280w x 425d
- C 150h x 280w x 425d
- D 95h x 280w x 425d

garment service locker

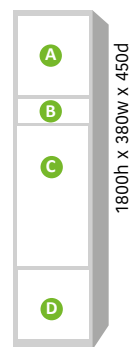

- A 400h x 320w x 425d
- B 145h x 320w x 425d
- C 830h x 320w x 425d
- D 310h x 320w x 425d

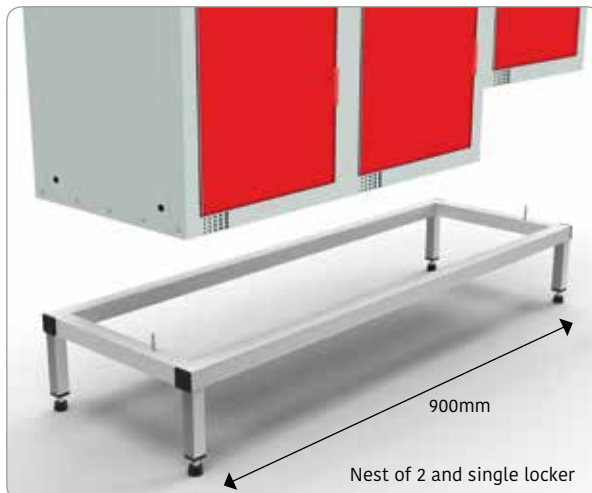
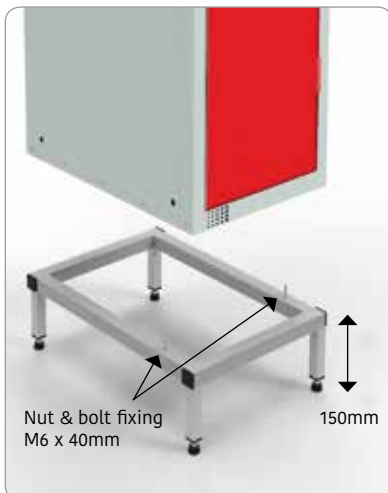
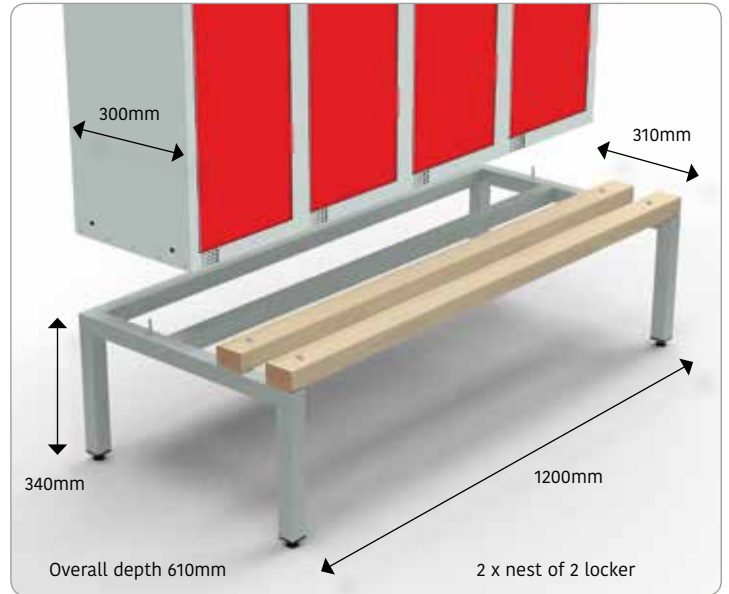
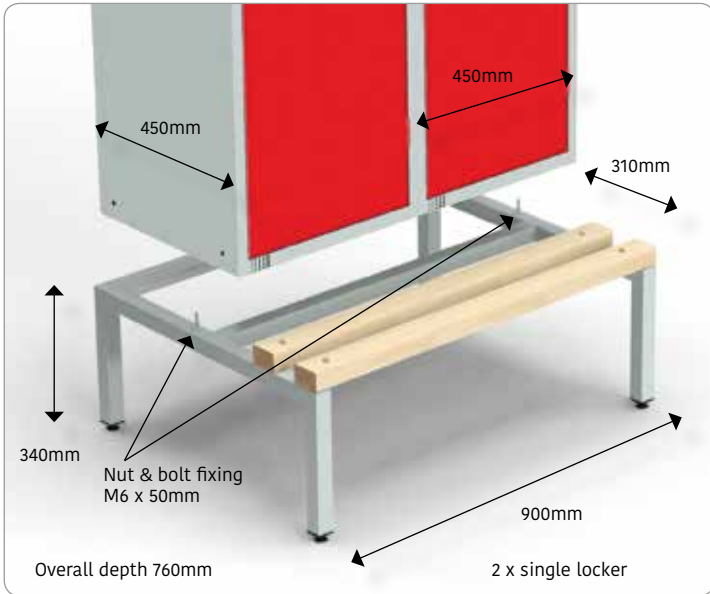
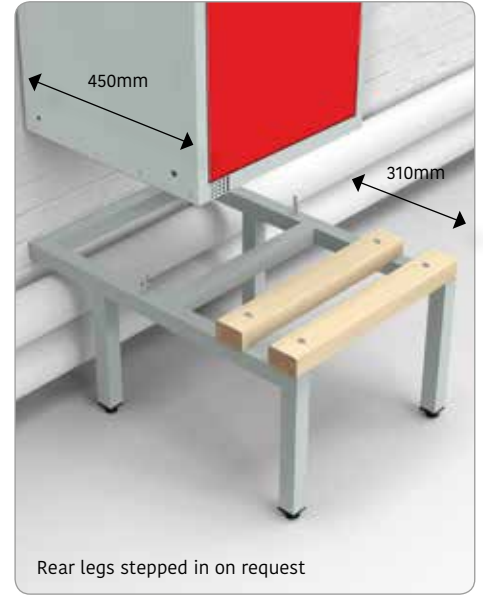
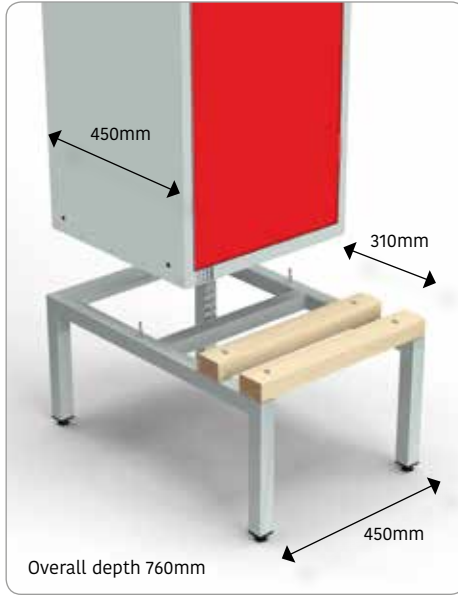
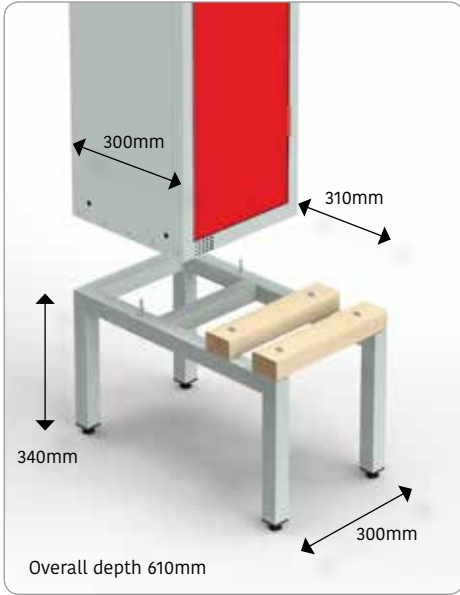

elite

range of products

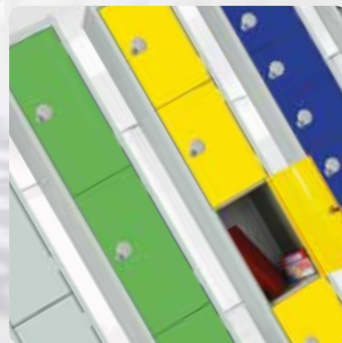

UK manufactured products

Authorised Distributor

